

DIY Installation Guide

Series 65 Tracks

Before You Start

TOOLS REQUIRED

- Measuring tape
- Pencil and paper
- Ladder
- Screwdriver
- Drill
- Spirit level
- Wall or ceiling plugs
- Appropriate fixing screws
- Straight edge (optional)

DON'T FORGET TO

- Carefully open the package and inspect the Goods for any damage during shipping
- Check that the enclosed quantity, colour, brackets and accessories of your Goods matches your Order Invoice and the completed Quality Control checklist enclosed
- Notify Decorators Market within 7 days if you find any issues with the Goods

PAY ATTENTION TO

- The mounting surface which needs to provide adequate structural support to withstand the weight of the curtains.
- Ensuring there are no hidden pipes, cables, asbestos or metal beams behind where the screws will be drilled in to. Decorators Market recommends you seek professional assistance before you install.
- Componentry such as glides, runners, hooks and grub screws can break, or get lost, if not handled with care

MOST IMPORTANTLY



Installing your own curtain rods and tracks is a relatively simple DIY task. However, if you are unsure about installing them yourself, we always recommend you contact a professional Installer first.

DIY Installation Guide

Installation Instructions

STEP 1 - INSPECT THE BRACKETS

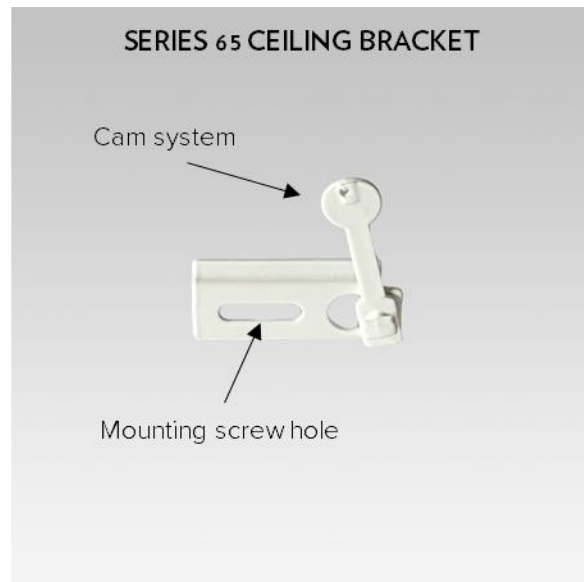
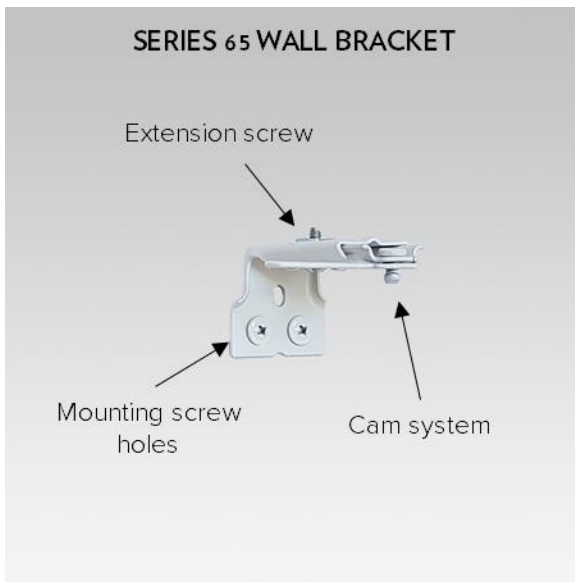

STEP 2 - ESTIMATE THE BRACKET SPACING

1. Your curtain tracks come with the appropriate number of brackets based on the track length. We strongly recommend you use all the brackets supplied to install your curtain tracks
2. As a general guide, spacing between brackets should be between 600mm – 1200mm depending on the weight of the curtains (closer brackets for heavier curtains).
3. It is also recommended that the end brackets are installed at least 150mm from the ends of the track to ensure better weight distribution
4. To calculate the approx. spacing between the brackets, use the following formula:

$(\text{Total track length} - 300\text{mm}) / (\text{number of brackets} - 1) = \text{approx. spacing between brackets}$

Example: 3.3m curtain track supplied with 4 brackets

$(3300\text{mm} - 300\text{mm}) / (4 - 1) = 1,000\text{mm}$ spacing between brackets

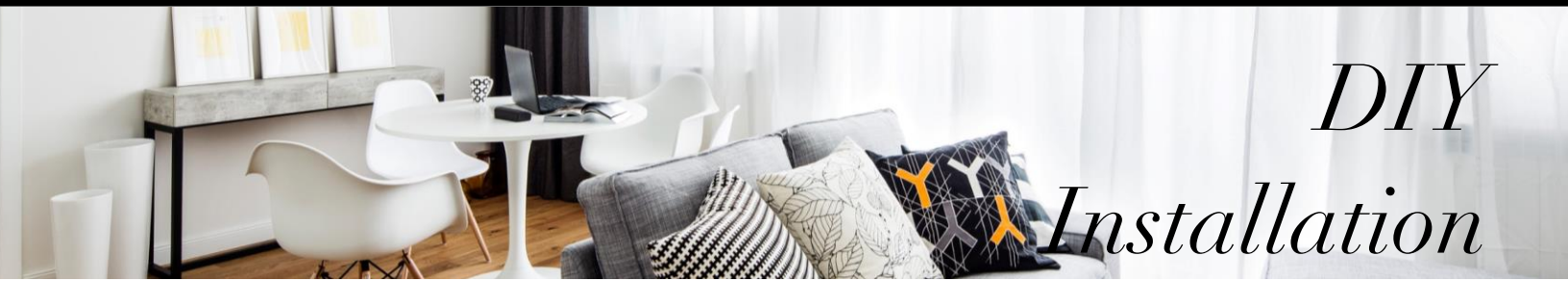

DIY Installation Guide

5. Adjust the spacing as required if you want to line the brackets up with any wall studs or ceiling rafters for a stronger installation
6. If you have heavy curtains that stack to one side, we also recommend reducing the bracket spacing on the side where the curtains will stack to approx 600mm
7. If you have an even number of brackets, or if your spacing doesn't include a bracket in the very centre of the track, you will need to calculate the distances from the estimated centre of the curtain track to the first brackets on either side of the centre
8. Record all of your bracket spacing details on a piece of paper

TOP VIEW (BRACKET SPACING)

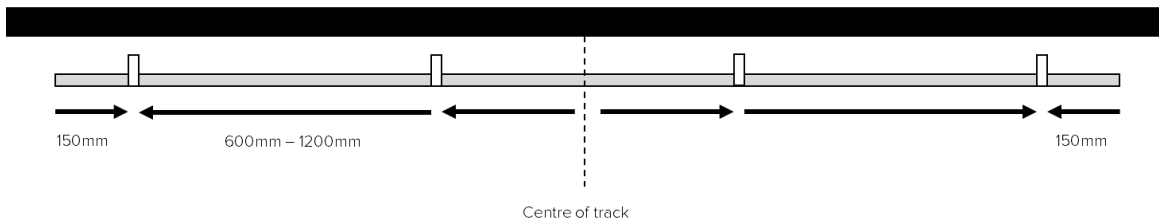

STEP 3A - MARK AND INSTALL THE WALL BRACKETS

1. Measure the width of the wall where the track is to be installed and lightly mark where you want the centre of the track to be positioned
2. Using your measurements calculated in Step 2(8), lightly mark where the first brackets on either side of the centre of the track should go
3. Lightly mark the approx. horizontal spacing of the remaining brackets based on the measurements you recorded in Step 2
4. **If Your Floors, Windows and Ceiling Are Level And Parallel**
 - a) If your floor, window frame and ceiling are all level and perfectly parallel to each other, measure the height from the floor to one of the centre brackets and make a light mark on the wall for the height. If you've already had your curtains made, we recommend checking with your workroom on the height they used for determining the curtain drop
 - b) Working from the centre outwards, measure the height of the remaining brackets from the floor and use your Spirit Level to check that the marks you have made for the brackets are level
 - c) An alternate method if your ceiling is level and parallel to the floor is to measure down from the ceiling or cornice to the required bracket height

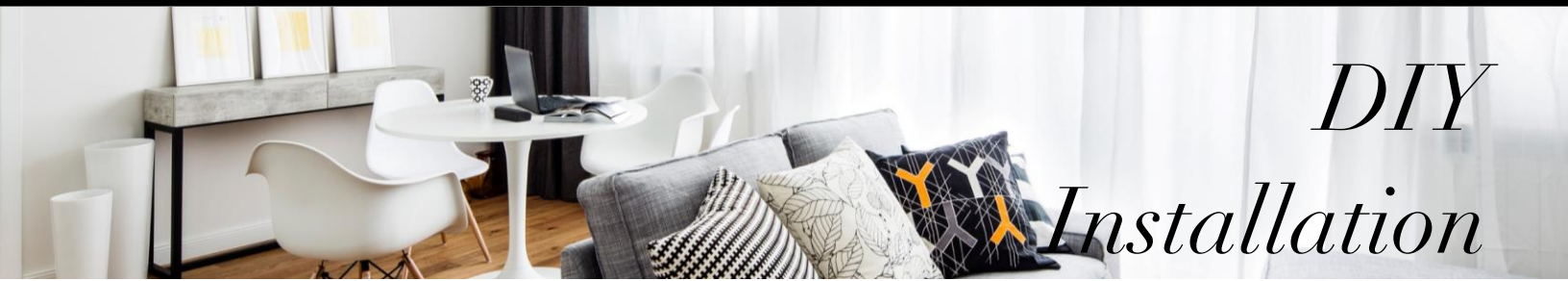

DIY Installation Guide

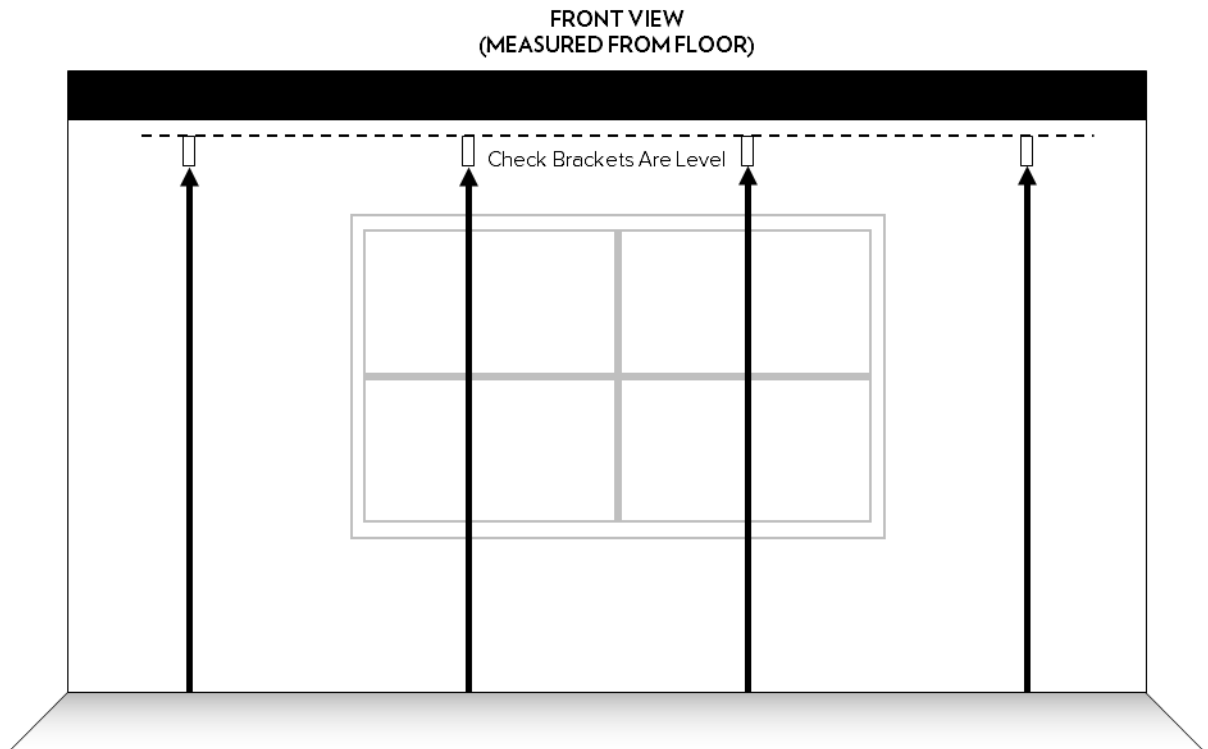

5. If Your Floors, Windows and Ceiling Are Not Level Or Parallel

- a) It's not uncommon for the floor, windows and ceiling to be at slightly different angles to each other (particularly in older homes) which means you need to choose what your curtains run parallel to
- b) We recommend aligning the curtains to the top of the window frame, or the ceiling, rather than floor. Whilst this may result in a gap along the bottom of the curtain and the floor, this is often less noticeable than the top of the curtain not being parallel with the ceiling
- c) If aligning to the ceiling or window frame, measure the required distance to the centre bracket and mark the wall
- d) Working from the centre outwards, mark the height of the remaining brackets, ensuring you use the exact same measurement from the window frame or ceiling
- e) Use your Spirit Level to check that the marks you have made are in a straight line with each other

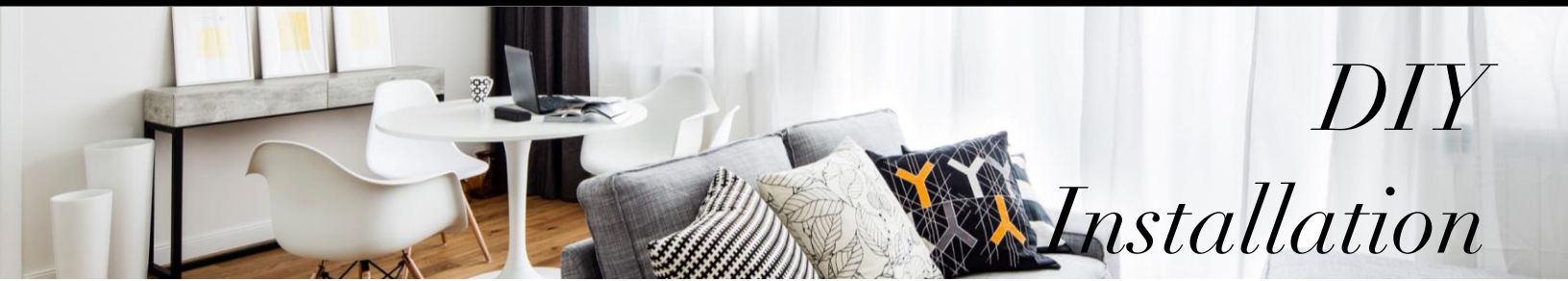

DIY Installation Guide

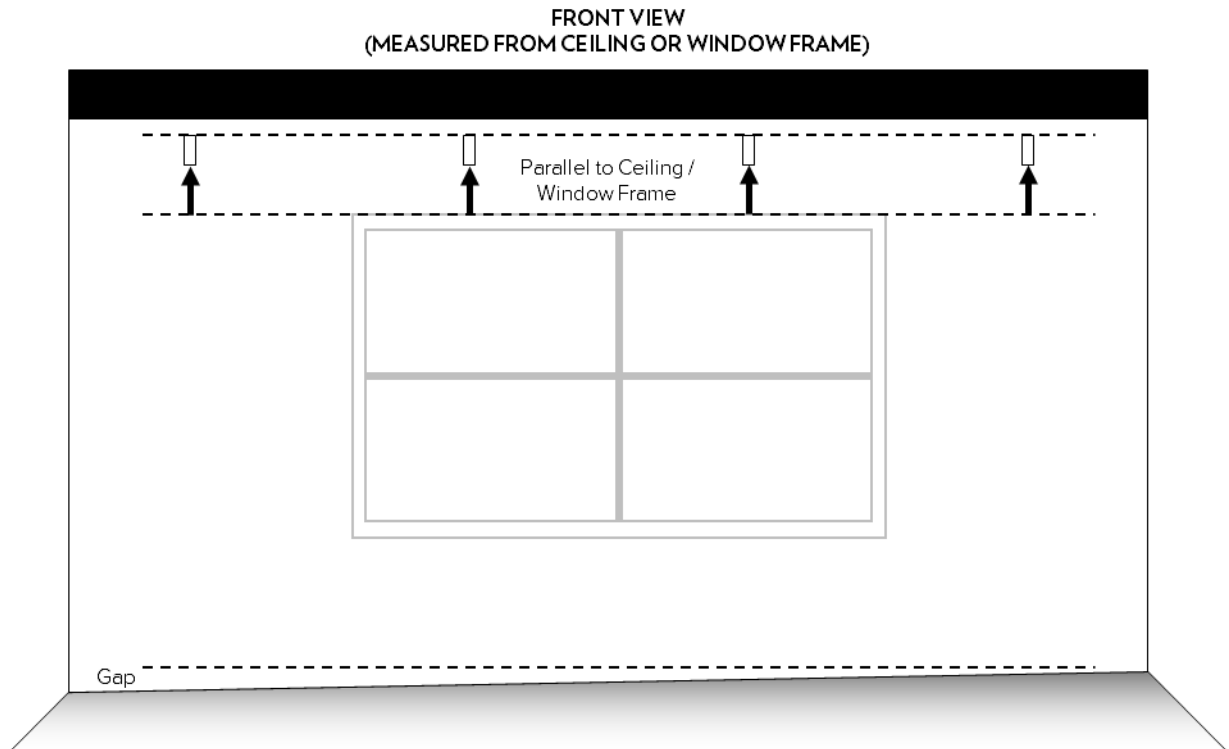

6. Check that the wall area behind each bracket is flush and suitable for fixing the bracket to it

NOTE: Before you install the brackets, make sure you have selected an appropriate method for fixing them securely to your wall. Decorators Market recommends you consult a Builder or professional Installer about the best way to fix your brackets based on your wall type.

7. To install the brackets, we recommend starting from the centre and working your way outwards
8. Position the first bracket on the wall where your mark was, and use your pencil to mark the screw hole positions
9. Drill the holes based on your chosen method of fixing the brackets and insert any plugs as appropriate
10. Screw the bracket onto the wall and fasten so it is secure but not too tight (may need adjustment later)
11. Install the next bracket by repeating Steps 3A(8) – 3A(10)
12. Use your Spirit Level to make sure the two brackets are level. Depending on your bracket type, you may be able to adjust the bracket up or down to get it perfectly level
13. Repeat these steps for the remainder of the brackets
14. Once you are happy with the heights and levels of all of the brackets, tighten the screws firmly

DIY Installation Guide

STEP 3B - MARK AND INSTALL THE CEILING BRACKETS

1. Measure the width of the ceiling where the track is to be installed and lightly mark where you want the centre of the track to be positioned
2. Using your measurements calculated in Step 2(8), lightly mark where the first brackets on either side of the centre of the track will be
3. Lightly mark the approx. horizontal spacing of each bracket along the ceiling based on the measurements you recorded in Step 2.
4. Next, measure the distance from side wall to each bracket to be installed and make a light mark on the ceiling. Tip: Be careful not to install your brackets too close to the wall as this may prevent the curtain folds from hanging correctly
5. Using your Spirit Level, check that the marks you have made for the brackets are in line and an even distance from the side wall
6. Also check that the ceiling area above each bracket is flush and suitable for fixing the bracket to it

TOP VIEW (CEILING FIX)



NOTE: Before you install the brackets, make sure you have selected an appropriate method for fixing them securely to your ceiling. Decorators Market recommends you consult a Builder or professional Installer about the best way to fix your brackets based on your ceiling type.

7. To install the brackets, we recommend starting from the centre and working your way outwards
8. Position the first bracket on the ceiling where your mark was, and use your pencil to mark the screw hole positions
9. Drill the holes based on your chosen method of fixing the brackets and insert any plugs as appropriate
10. Screw the bracket onto the ceiling and fasten so it is secure but not too tight (may need adjustment later)
11. Install the next bracket by repeating Steps 3B(8) – 3B(10)
12. Use your Spirit Level to make sure the two brackets are in line. Depending on your bracket type, you may be able to adjust the bracket position slightly to get it in line
13. Repeat these steps for the remainder of the brackets
14. Once you are happy with the spacing and alignment of all the brackets, tighten the screws firmly

DIY Installation Guide

STEP 5 - ATTACH THE TRACK

1. The Series 65 uses a cam system to attach the track to the bracket
2. Starting with one of the middle brackets, align the cam shaft with the middle of the underside of the bracket so that the round end is pointing towards the wall
3. Carefully position the groove on the top of the track over the metal cam on the bracket
4. Rotate the cam shaft anti-clockwise by 90 degrees to lock the track into place
5. Repeat for each of the remaining brackets

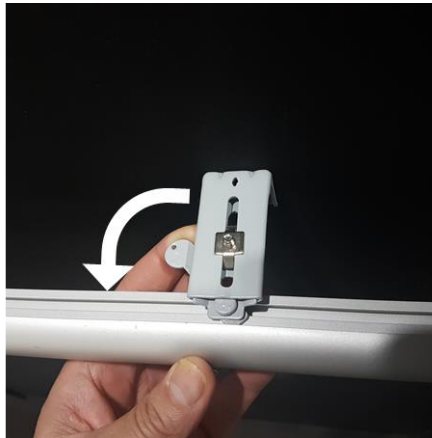

STEP 6 - ADJUST THE TRACK

1. Once the track is attached to the brackets, you can loosen the extension screw (wall brackets) or mounting screw (ceiling brackets) to slide the bracket closer or further to the wall
2. Securely tighten the screws once you are happy with the position of the track