

# *DIY Installation Guide*

## *Series 58 Tracks*

### *Before You Start*

---

#### **TOOLS REQUIRED**

- Measuring tape
- Pencil and paper
- Ladder
- Screwdriver
- Drill
- Spirit level
- Wall or ceiling plugs
- Appropriate fixing screws
- Straight edge (optional)

#### **DON'T FORGET TO**

- Carefully open the package and inspect the Goods for any damage during shipping
- Check that the enclosed quantity, colour, brackets and accessories of your Goods matches your Order Invoice and the completed Quality Control checklist enclosed
- Notify Decorators Market within 7 days if you find any issues with the Goods

#### **PAY ATTENTION TO**

- The mounting surface which needs to provide adequate structural support to withstand the weight of the curtains.
- Ensuring there are no hidden pipes, cables, asbestos or metal beams behind where the screws will be drilled in to. Decorators Market recommends you seek professional assistance before you install.
- Componentry such as glides, runners, hooks and grub screws can break, or get lost, if not handled with care

#### **MOST IMPORTANTLY**



Installing your own curtain rods and tracks is a relatively simple DIY task. However, if you are unsure about installing them yourself, we always recommend you contact a professional Installer first.

# DIY Installation Guide

## Installation Instructions

### STEP 1 - INSPECT THE BRACKETS

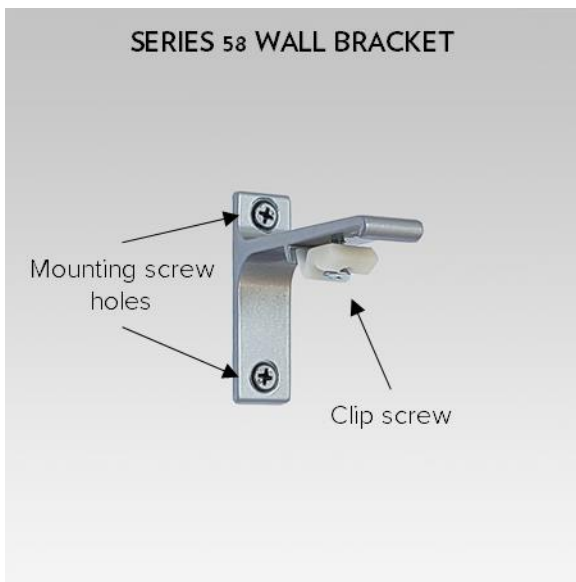

### STEP 2 - ESTIMATE THE BRACKET SPACING

1. Your curtain tracks come with the appropriate number of brackets based on the track length. We strongly recommend you use all the brackets supplied to install your curtain tracks
2. As a general guide, spacing between brackets should be between 600mm – 1200mm depending on the weight of the curtains (closer brackets for heavier curtains).
3. It is also recommended that the end brackets are installed at least 150mm from the ends of the track to ensure better weight distribution
4. To calculate the approx. spacing between the brackets, use the following formula:

$(\text{Total track length} - 300\text{mm}) / (\text{number of brackets} - 1) = \text{approx. spacing between brackets}$

*Example: 3.3m curtain track supplied with 4 brackets*

$(3300\text{mm} - 300\text{mm}) / (4 - 1) = 1,000\text{mm}$  spacing between brackets

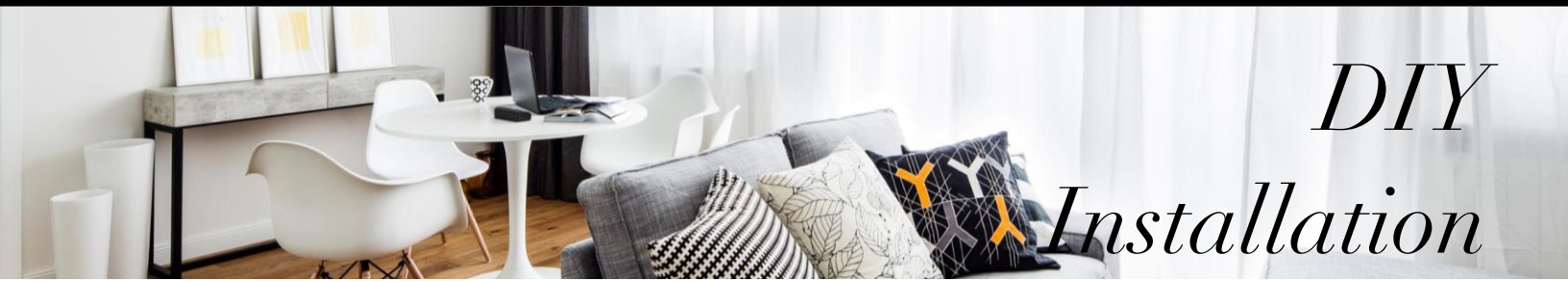

# DIY Installation Guide

5. Adjust the spacing as required if you want to line the brackets up with any wall studs or ceiling rafters for a stronger installation
6. If you have heavy curtains that stack to one side, we also recommend reducing the bracket spacing on the side where the curtains will stack to approx 600mm
7. If you have an even number of brackets, or if your spacing doesn't include a bracket in the very centre of the track, you will need to calculate the distances from the estimated centre of the curtain track to the first brackets on either side of the centre
8. Record all of your bracket spacing details on a piece of paper

TOP VIEW (BRACKET SPACING)

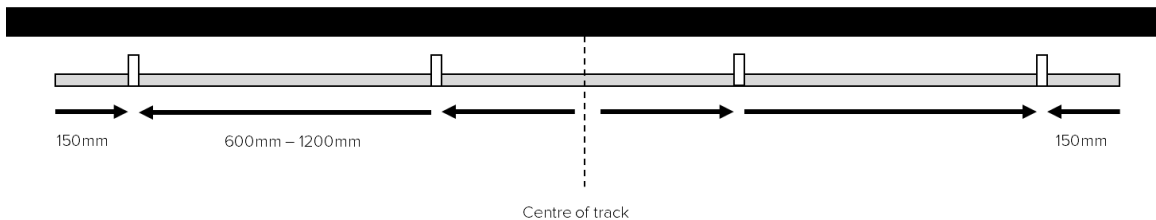

## STEP 3A - MARK AND INSTALL THE WALL BRACKETS

1. Measure the width of the wall where the track is to be installed and lightly mark where you want the centre of the track to be positioned
2. Using your measurements calculated in Step 2(8), lightly mark where the first brackets on either side of the centre of the track should go
3. Lightly mark the approx. horizontal spacing of the remaining brackets based on the measurements you recorded in Step 2
4. **If Your Floors, Windows and Ceiling Are Level And Parallel**
  - a) If your floor, window frame and ceiling are all level and perfectly parallel to each other, measure the height from the floor to one of the centre brackets and make a light mark on the wall for the height. If you've already had your curtains made, we recommend checking with your workroom on the height they used for determining the curtain drop
  - b) Working from the centre outwards, measure the height of the remaining brackets from the floor and use your Spirit Level to check that the marks you have made for the brackets are level
  - c) An alternate method if your ceiling is level and parallel to the floor is to measure down from the ceiling or cornice to the required bracket height

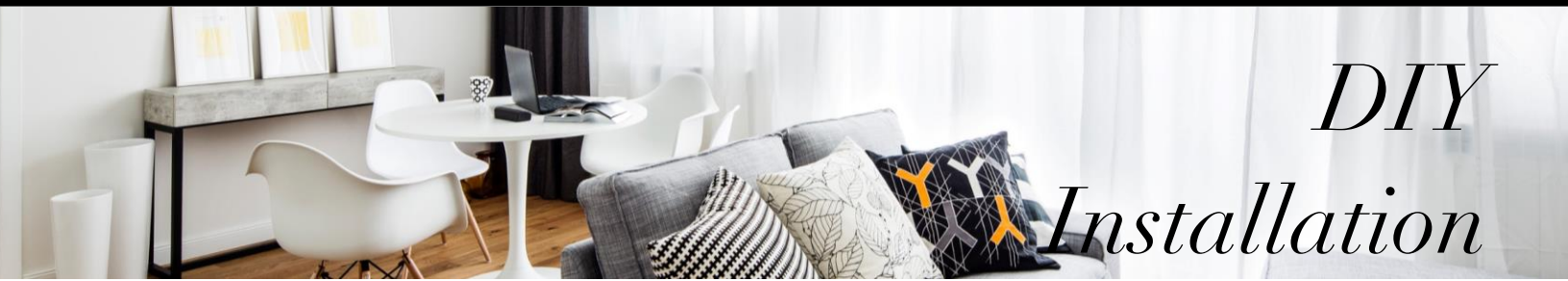

# *DIY Installation Guide*

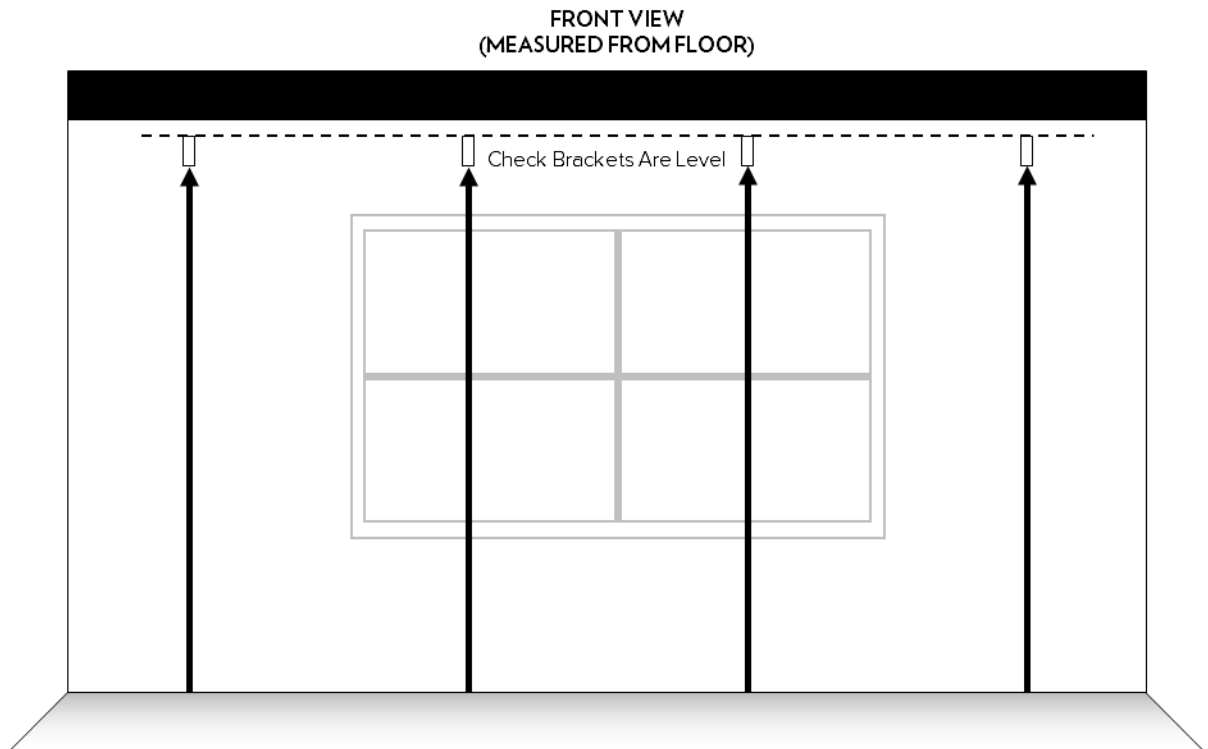

## 5. If Your Floors, Windows and Ceiling Are Not Level Or Parallel

- a) It's not uncommon for the floor, windows and ceiling to be at slightly different angles to each other (particularly in older homes) which means you need to choose what your curtains run parallel to
- b) We recommend aligning the curtains to the top of the window frame, or the ceiling, rather than floor. Whilst this may result in a gap along the bottom of the curtain and the floor, this is often less noticeable than the top of the curtain not being parallel with the ceiling
- c) If aligning to the ceiling or window frame, measure the required distance to the centre bracket and mark the wall
- d) Working from the centre outwards, mark the height of the remaining brackets, ensuring you use the exact same measurement from the window frame or ceiling
- e) Use your Spirit Level to check that the marks you have made are in a straight line with each other

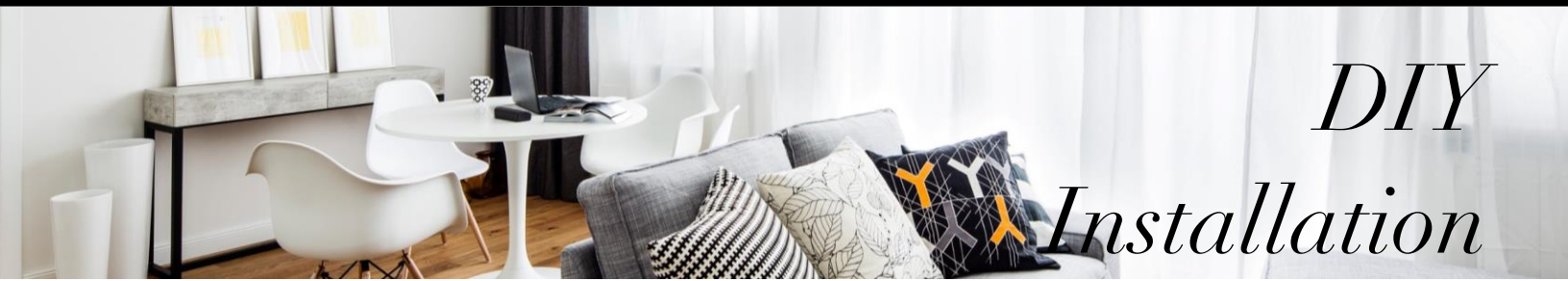

# DIY Installation Guide

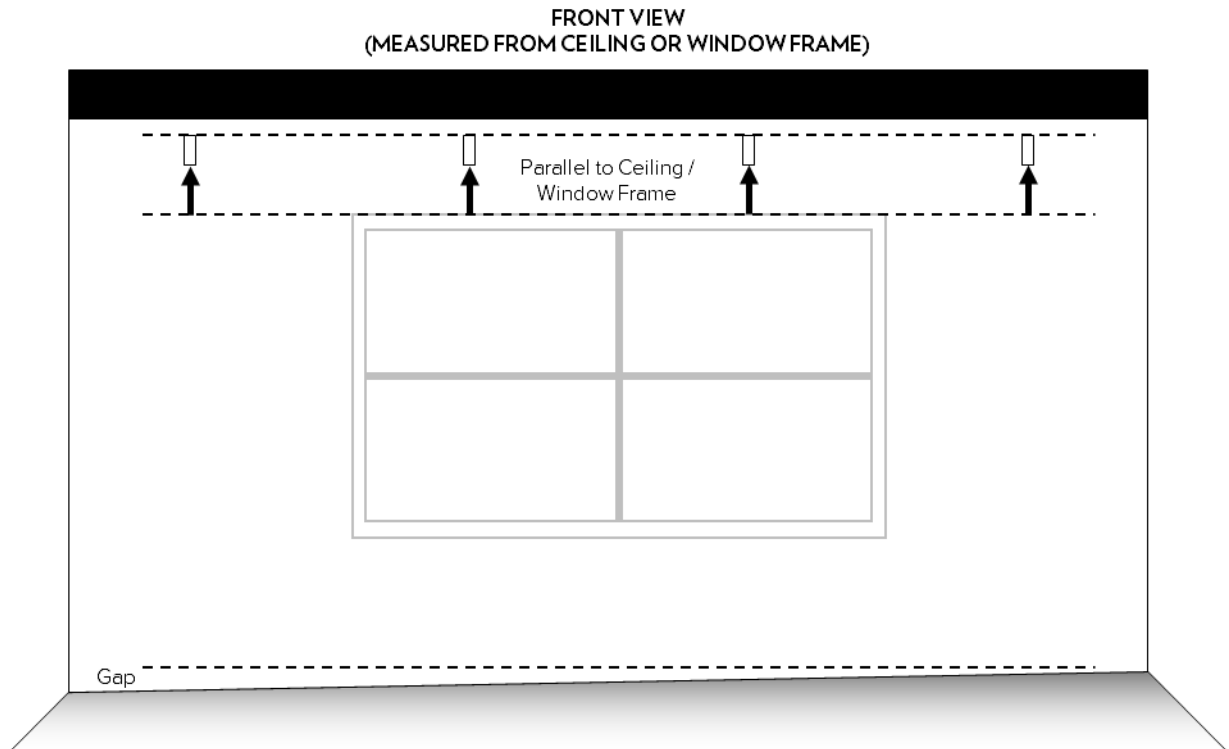

6. Check that the wall area behind each bracket is flush and suitable for fixing the bracket to it

**NOTE:** Before you install the brackets, make sure you have selected an appropriate method for fixing them securely to your wall. Decorators Market recommends you consult a Builder or professional Installer about the best way to fix your brackets based on your wall type.

7. To install the brackets, we recommend starting from the centre and working your way outwards
8. Position the first bracket on the wall where your mark was, and use your pencil to mark the screw hole positions
9. Drill the holes based on your chosen method of fixing the brackets and insert any plugs as appropriate
10. Screw the bracket onto the wall however do not tighten the screws as they need to be loose in order to clip on the track
11. Install the next bracket by repeating Steps 3A(8) – 3A(10)
12. Use your Spirit Level to make sure the two brackets are level
13. Repeat these steps for the remainder of the brackets

# DIY Installation Guide

## STEP 3B - MARK AND INSTALL THE CEILING BRACKETS

1. Measure the width of the ceiling where the track is to be installed and lightly mark where you want the centre of the track to be positioned
2. Using your measurements calculated in Step 2(8), lightly mark where the first brackets on either side of the centre of the track will be
3. Lightly mark the approx. horizontal spacing of each bracket along the ceiling based on the measurements you recorded in Step 2.
4. Next, measure the distance from side wall to each bracket to be installed and make a light mark on the ceiling. Tip: Be careful not to install your brackets too close to the wall as this may prevent the curtain folds from hanging correctly
5. Using your Spirit Level, check that the marks you have made for the brackets are in line and an even distance from the side wall
6. Also check that the ceiling area above each bracket is flush and suitable for fixing the bracket to it

TOP VIEW (CEILING FIX)



**NOTE:** Before you install the brackets, make sure you have selected an appropriate method for fixing them securely to your ceiling. Decorators Market recommends you consult a Builder or professional Installer about the best way to fix your brackets based on your ceiling type.

7. To install the brackets, we recommend starting from the centre and working your way outwards
8. Position the first bracket on the ceiling where your mark was, and use your pencil to mark the screw hole positions
9. Drill the holes based on your chosen method of fixing the brackets and insert any plugs as appropriate
14. Screw the bracket onto the ceiling however do not tighten the screw as it needs to be loose in order to clip on the track
10. Install the next bracket by repeating Steps 3B(8) – 3B(10)
11. Use your Spirit Level to make sure the two brackets are in line
12. Repeat these steps for the remainder of the brackets



# *DIY Installation Guide*

## **STEP 5 - ATTACH THE TRACK**

1. The Series 58 uses a clip system to attach the track to the bracket. Starting with one of the middle brackets, ensure the clip screw is loose
2. Hold the track up to the bracket and position the groove on top of the track in to the metal notch on the bracket
3. With an upward motion, rotate the track so the rear groove snaps in to the plastic mounting clip. Note: You may need to apply a decent amount of upward pressure to snap the track into place and we recommend supporting the top of the bracket with your other hand to prevent damaging your wall fixing
4. Repeat for each of the remaining brackets



## **STEP 6 - ADJUST THE TRACK**

1. Once the track is attached to the brackets, you can adjust the track slightly left or right to centre it on the wall or ceiling
2. Securely tighten the mounting screws once you are happy with the position of the track
3. For ceiling brackets, slide on the bracket covers to hide the clip and mounting screws